

SJR3
ACCESSORY

Advanced Dungeons & Dragons
2nd Edition

9313

SPELLJAMMER™

Official Game Accessory

Dungeon Master's Screen

E. OLSON

SPELLJAMMER™ DMSCREEN

SPELLJAMMER™ Campaign Screens, Ships, and Space

Welcome to the SPELLJAMMER Dungeon Master's Screen. This DM Screen contains many useful tables and charts from the *Dungeon Master's Guide* and the SPELLJAMMER boxed set, and will allow you to spend more time enjoying your SPELLJAMMER campaigns rather than spending time looking for facts and figures. In addition, the screen is graced by a fantastic panorama painting of battles in wild-space, a feature sure to please your players. This package also contains many full color, 3-dimensional fold-up ships to add color and style to your space battles. With all these features, you will no doubt find endless hours of use for this SPELLJAMMER product.

Space-faring ships take on new dimensions!

In the SPELLJAMMER boxed set, there are a number of silhouette ship counters for use in ship-to-ship combat; the full color, 3-dimensional fold-up ships in this product are a great enhancement from the original counters. The ships are now in a variety of sizes, bringing them closer to scale in size. Even with the improved ship counters, the scale is not perfect since many ships in the SPELLJAMMER campaign setting are simply too large to make in scale.

Although these 3-D ship counters are different from the original ship counters, they can still be used together. They both only represent the approximate placement of a spelljamming ship on the starfield tactical map; remember that each hex of the map represents 500 yards of space, and many ships should fit into that space. The fold-ups simply improve your game with a better visual display of the ships involved in combat, allowing details of each ship as well as relative size to play a role in the game.

When each of the fold-ups is com-

plete, it will stand upon a one inch rectangular base: the same length of one hex on the tactical map sheet in the SPELLJAMMER boxed set. The ship itself will determine its facing—the direction of the rams on a squid ship and the base beneath them represents the front facing of the ship. During ship movement and battles on the starfield map, the front of the base should be aligned with one side of the hex the ship is occupying. If there is any question as to where a ship is and which direction it is facing, the Dungeon Master is, of course, the final arbitrator.

The fold-ups are fairly simple to assemble, though it is helpful to have a picture of each ship ready for reference while putting them together. You may find the following items helpful in assembling the new 3-dimensional fold-ups: a hobby knife or razor blade and tape or white glue. **Warning: Children should NOT use a hobby knife or a razor blade without direct supervision of a parent or other adult, as these tools can be harmful if not used properly.** Also, glue is recommended rather than tape since tape is visible on the outside of the fold-ups and can detract from their overall appearance.

Once you have gathered all of your materials, you are ready to begin assembling your fold-ups. Each piece is perforated, so carefully punch them out of the page. It is recommended that you punch only the pieces of one ship at a time to avoid getting parts mixed up or possibly lost. Each punch-out piece has "score" lines on them: lines pressed into the paper to provide a guide for folding it. As shown in the diagrams on the next page, fold the main body of the the ship to form the base into a 3-dimensional triangle. The left and right side of the body should go flat against each other and be glued or taped together. Then, if the piece has any accessory (wings, legs, etc.), break the perforation line on the ship and slide the accessory piece into place. Once this is done, the fold-up is complete and ready for play!

Out of Drydock & Into Play

The color and detail of the ship fold-ups makes them ideal display pieces, but they were designed primarily for use in ship-to-ship combat. When preparing for ship combat, creating matching opponents for your players can become a problem unless you pay attention to the following factors:

1. Ship tonnage and armor—the ship's size and strength of the ship
2. Ship maneuverability and speed; these stats are most important in terms of combat—they are both variable and should be relative to the PCs' ship. Keep in mind the SR of the ship and the helms involved: a 12th level priest on a major helm is more beneficial to a ship's SR than a 17th level mage on a minor helm.
3. Ships' weapons; a ship with 4 lt. catapults is formidable until it faces 3 mages with *wands of lightning!*
4. Crew—PCs' & opponents' levels; PCs' levels are important for balance in hand-to-hand combat, but ship-to-ship combat relies on the space experience of the crew as well as the adventurers on board. All the PCs' power cannot save a ship with an untried crew with no knowledge of ships or ships' weaponry.
5. Magic items; one mage with a *wand of fire* or any offensive magic item can seriously outweigh any weapons of the opponents. Magic item use must be carefully considered, ships needing fire resistance or another benefit to counter-balance the powers of any magic items.

When comparing one ship to another, look at things like those mentioned above. Think about beefing ships up in some areas while trimming other factors: ships with high AR tend to have a low SR or MC; ships heavy with magic items could have a green crew, etc. After some experimenting and play-testing, you will soon be on your way to designing fun and challenging ship-to-ship combat scenarios!

Assembly Instructions

Carefully punch out the pieces. It is suggested that you leave the smaller pieces on the cards until you are ready to attach them to the main ship. This keeps your pieces from being mixed up or lost.

Before gluing, gently flex pieces back and forth along the (scored) fold-lines. A white glue is recommended for assembling your foldup ship. When applying glue, apply evenly over the entire surface to be joined. Wipe away excess with your finger until only a thin, shiny layer of glue remains. Glue should not seep out when you press pieces together.

- ① Apply glue to inside of ship and fold together.

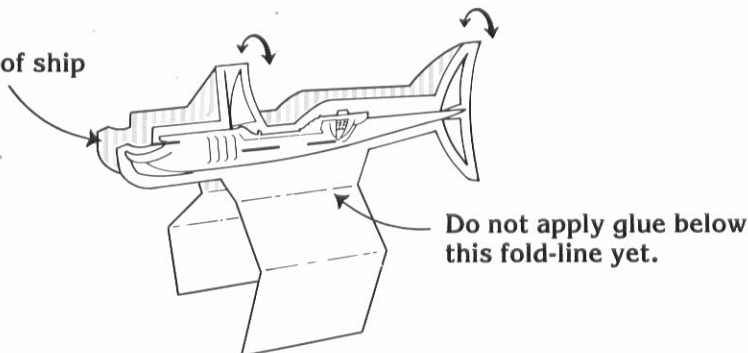

- ② Press halves together for a few seconds till glue sets. Set aside and allow the glue to dry. While waiting, you can proceed with this step on other ships.

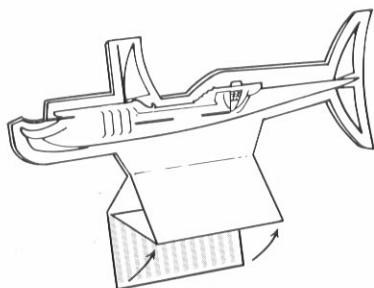
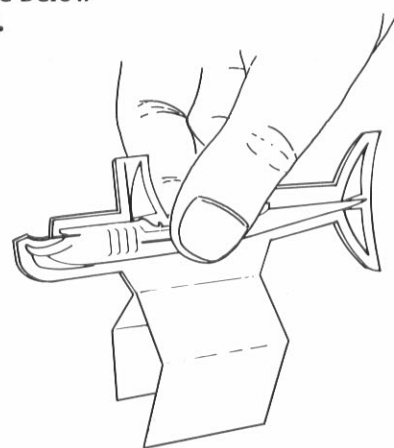

- ③ After your glue has dried from the above step, apply glue to the underside of a bottom flap. Fold up the unglued flap first, then fold over the flap to which glue is applied.

- ④ Using a pencil, press down lightly on the inner part of the base. Hold steady for a few seconds to set the glue and allow to dry.

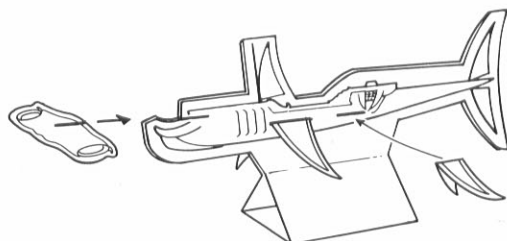
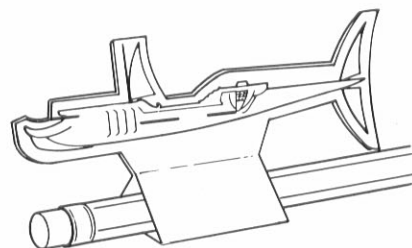

- ⑤ Punch out the pieces remaining for the ship and insert them into the appropriate slots. Feel free to bend or curve the pieces as you see fit. The score lines provide a guide to where your ship pieces can best be folded.

Credits

Dungeon Master's Screen
Presentation and Layout by J. Paul LaFountain
and Steven E. Schend

Spacefaring Ship Foldups
Design and Graphics by Diesel

The bases have a one inch length, and they can easily be used with the tactical star map included in the SPELLJAMMER™ campaign boxed set.



E. OLSON







Weapon	Range	Hull Damage	Personal Damage	ROF	Crew	THACO	Crit. Hit
Light Ballista	6	0	2-12	1/2	1	12	—
Medium Ballista	4	1-3	3-18	1/3	2	14	20
Heavy Ballista	2	3-6	3-30	1/4	4	17	19+
Light Catapult	5	1-2	2-20	1/2	1	14	20
Medium Catapult	4	2-4	3-30	1/2	3	15	19+
Heavy Catapult	3	2-8	3-30	1/3	5	16	18+
Bombard	2	1-6	2-20	1-3	3	17	20
Light Jettison	3	0	1-6	1/2	2	14	—
Medium Jettison	2	0	2-12	1/3	3	15	—
Heavy Jettison	1	0	3-18	1/4	4	16	—
Greek Fire Projector	1	1-3	3-30	1/4	3	16	18+
Missile Weapons							
Arquebus	1(l)	0	1-10	1/3	1	U	—
Comp Long Bow							
Flight Arrow	1(l)	0	1-6	2/1	1	U	—
Sheaf Arrow	0	0	1-8	2/1	1	U	—
Comp Short Bow							
Flight Arrow	0	0	1-6	2/1	1	U	—
Long Bow							
Flight Arrow	1(l)	0	1-6	2/1	1	U	—
Sheaf Arrow	0	0	1-8	2/1	1	U	—
Short Bow							
Flight Arrow	0	0	1-6	2/1	1	U	—
Heavy Crossbow	1(l)	0	1-4+1	1/2	1	U	—
Light Crossbow	0	0	1-4	1	1	U	—
Sling							
Bullet	1(l)	0	1-4+1	1	1	U	—
Stone	0	0	1-4	1	1	U	—

No other missile weapons are significant enough to rate at this scale, though they are useful in ramming, boarding, and melee situations. The hand-held missile weapons marked 1(l) are capable of hitting at a range of one hex, but this is considered long range. Missiles marked with a range of 0 can be used only if the target ship is in the same hex as with the attacker.

U = User's level used to figure THACO.

SHIP'S RATING USING MAJOR AND MINOR HELMS		
Level of Wizard or Priest	Major helm	Minor helm
1	1	1
2	1	1
3	1	1
4	2	1
5	2	1
6	3	2
7	3	2
8	4	2
9	4	3
10	5	3
11	5	3
12	6	4
13	6	4
14	7	4
15	7	5
16	8	5
17	8	5
18	9	6
19	9	6
20	10	6

CRITICAL HIT TABLE	
Roll	Result
1	Loss of 5 hull points
2	Deck Crew Casualty
3	Interior Crew Casualty
4	Ship Shaken
5	Large Weapon Damaged
6	Deck Crew Casualty
7	Hull Holed
8	Maneuverability Loss
9	Loss of 10 Hull Points
10	Ship Shaken
11	Fire!
12	Loss of SR
13	Deck Crew Casualty
14	Large Weapon Damaged
15	Ship Shaken
16	Hull Holed
17	Maneuverability Loss
18	Loss of 10 Hull Points
19	Loss of SR
20	Spelljammer Shock!

COVER & CONCEALMENT MODIFIERS		
Target is:	Cover	Concealment
25% hidden	-2	-1
50% hidden	-4	-2
75% hidden	-7	-3
90% hidden	-10	-4

COMBAT MODIFIERS	
Situation	Attack Roll Modifier
Attacker on higher ground	+1
Defender invisible	-4
Defender off-balance	+2
Defender sleeping or held	Automatic
Defender stunned or prone	+4
Defender surprised	+1
Missile fire, long range	-5
Missile fire, medium range	-2
Rear attack	+2

CALCULATED THAC0s

Group	Level																			
	1	2	3	4	5	6	7	8	9	10	11	12	13	14	15	16	17	18	19	20
Priest	20	20	20	18	18	18	16	16	16	14	14	14	12	12	12	10	10	10	8	8
Rogue	20	20	19	19	18	18	17	17	16	16	15	15	14	14	13	13	12	12	11	11
Warrior	20	19	18	17	16	15	14	13	12	11	10	9	8	7	6	5	4	3	2	1
Wizard	20	20	20	19	19	19	18	18	18	17	17	17	16	16	16	15	15	15	14	14

CREATURE THAC0s

1/2 or less	Hit Dice															
	1-1	1+	2+	3+	4+	5+	6+	7+	8+	9+	10+	11+	12+	13+	14+	15+
20	20	19	19	17	15	15	13	13	11	11	9	9	7	7	5	5

The THAC0 of creatures continues to decrease by 2 points per 2 Hit Dice beyond 16.

CHARACTER SAVING THROWS

Character Group and Experience Level	Attack to be Saved Against					
	Paralyzation, Poison, or Death Magic	Rod, Staff, or Wand	Petrification or Polymorph*	Breath Weapon†	Spell‡	
Priests	1-3	10	14	13	16	15
	4-6	9	13	12	15	14
	7-9	7	11	10	13	12
	10-12	6	10	9	12	11
	13-15	5	9	8	11	10
Rogues	1-4	13	14	12	16	15
	5-8	12	12	11	15	13
	9-12	11	10	10	14	11
	13-16	10	8	9	13	9
	17-20	9	6	8	12	7
Warriors	0	16	18	17	20	19
	1-2	14	16	15	17	17
	3-4	13	15	14	16	16
	5-6	11	13	12	13	14
	7-8	10	12	11	12	13
Wizards	1-5	14	11	13	15	12
	6-10	13	9	11	13	10
	11-15	11	7	9	11	8
	16-20	10	5	7	9	6
	21+	8	3	5	7	4

* Excluding *polymorph wand* attacks.

† Excluding those that cause petrification or polymorph.

‡ Excluding those for which another saving throw type is specified, such as death, petrification, polymorph, etc.

Intelligent monsters (animal intelligence or more) make all saves at a level equal to their Hit Dice. Non-intelligent monsters save vs. poison and death at a level equal to their Hit Dice and save vs. all else at a level equal to half their Hit Dice. Count an additional Hit Die for every four added hit points (or fraction thereof). Most monsters save as Warriors. Those with special abilities that resemble another group can use the more advantageous saving number.

ITEM SAVING THROWS

Item	Acid	Crushing Blow ¹	Disin.	Fall	Magical Fire	Normal Fire ²	Cold	Light	Elec. ⁴
	Bone	11	16	19	6	9	3	2	8
Cloth	12	—	19	—	16	13	2	18	2
Glass	4	20	19	14	7	4	6	17	2
Leather	10	3	19	2	6	4	3	13	2
Metal ³	13	7	17	3	6	2	2	12	2
Ceramics	4	18	19	11	2	2	4	2	2
Crystal	3	17	18	8	3	2	2	14	2
Stone	3	17	18	8	3	2	2	14	2
Rope	12	2	19	—	10	6	2	9	2
Wood, thick	8	10	19	—	7	5	2	12	2
Wood, thin	9	13	19	2	11	9	2	10	2

¹ Crushing blow includes all crashes.

² Metal includes *glassteel* spells.

³ Normal fire includes greek fire.

⁴ Electricity includes all electricity less than lightning.



CREW COST TABLE

Green:	2 gp per standard month (inexperienced groundlings)
Average:	4 gp per standard month (Previous space sailing experience)
Trained:	6 gp per standard month (veterans of numerous space voyages)
Crack:	6 gp per standard month (experts on their own ships)

CREW MORALE

Crew is	Morale Value
Complete novices in space	9
Above, but military or mercenaries	10
Have been in space before	12
Above, but military or mercenaries	13
Elite space veterans	14
Mainly pirates	11

CREW INITIATIVE & MORALE MODIFIERS

If the Crew is:	Then Initiative is:
Green	+1
Average	Unmodified
Trained	-1
Crack	-2

Morale is also affected by the crew's status.

If the Crew is:	The Morale is:
Green	-1
Average	Unaffected
Trained	+2
Crack	+4

TYPICAL WEATHER CONDITIONS IN ATMOSPHERES

2D6 Roll	Spring/Fall	Summer	Winter
2	Becalmed	Becalmed	Becalmed
3	Becalmed	Becalmed	Light Breeze
4	Light Breeze	Becalmed	Light Breeze
5	Favorable	Light Breeze	Favorable
6	Favorable	Light Breeze	Strong Winds
7	Strong Winds	Favorable	Strong Winds
8	Storm	Favorable	Storm
9	Storm	Strong Winds	Storm
10	Gale	Storm	Gale
11	Gale	Gale	Gale
12	Hurricane*	Hurricane*	Hurricane*

* Hurricanes occur only if the previous day's weather was "Gale." Otherwise treat as gale force winds.

FIRE EFFECTS IN PHLOGISTON

The effects of various types of flame exposed to the phlogiston are as follows:

Candle (lit)	1 die fireball 4" across
Lantern (lit)	3 die fireball 1' across
Oil flask (lit)	3 die fireball 3' across
Cooking fire	4 die fireball 10' across
Fireball	3 times size and effect
Match (fuse)	1-2 points (plus immediate misfire if arquebus)

CELESTIAL BODY CLASSIFICATION

Size Classes:

Size A	Less than 10 miles across
Size B	From 10-100 miles across
Size C	From 100-1K (1000) miles across
Size D	From 1-4K across
Size E	From 4k-10K across
Size F	From 10K-40K across
Size G	From 40K-100K across
Size H	From 100K-1000K (1M) across
Size I	From 1M-10M across
Size J	10M across or greater

Earth, and most earth-like fantasy campaigns, are Size E.

The amount of time that it takes to get out of a planet's "gravity well" and attain full wildspace movement is determined by the planet's size:

Size Class A:	10 rounds (1 turn)
Size Class B & C:	2 turns
Size Class D:	3 turns
Size Class E:	4 turns
Size Class F:	6 turns
Size Class G:	12 turns
Size Class H:	24 turns (4 hrs)
Size Class I:	48 turns (8 hrs)
Size Class J:	96 turns (16 hrs)

Condition	Landing/ Takeoff	
	Time	Modifier
Becalmed	Normal	x1
Light Breeze	Normal	x1
Favorable	Normal	x1
Strong Winds	Time x2	x ^{1/2}
Rain or Snow	Time x2	x ^{1/2}
Storm	Time x4	x ^{1/4}
Gale	Time x4	x ^{1/4}
Hurricane	No takeoff or landing possible	

FIREARMS TABLE

Name	Cost	Weight	Size	Type	Speed	Base Damage	Additional
Arquebus	500	10	M	P	15	1d10/1d10	10
Blunderbuss	500	12	M	P	15	1d4/1d4	X
Bombard	20,000	2,000	H	P	20	2d20/2d20	20
Caviler	450	11	M	P	12	1d8/1d8	8
Musket	800	20	M	P	17	1d12/1d12	12
Ribald	1,200	80	L	P	10	1d4/1d4	X
Starwheel (wheel lock pistol)	1,000	5	S	P	10	1d4/1d4	4

Name	ROF	S	Range		Charge	Backfire	Backfire Dmg
			M	L			
Arquebus	1/3	5	15	21	1	1-2	1d6
Blunderbuss	1/3	1	2	3	1	1-2	1d6
Bombard	1/3†	50	100	200	10	1	2d10
Caviler	1/4	4	8	14	1	1-2	1d4
Musket	1/4	6	18	24	2	1-3	1d8
Ribald	1/24*	3	6	9	6	1	1d6
Starwheel (wheel lock pistol)	1/3	3	6	9	1	1-2	1d6

* 1/2 per each of 12 barrels

† Assuming a fully trained, three-man crew

Additional: If this number is rolled, score this much damage and roll again.

Charge: Number of charges of smoke powder required for one shot.

Backfire: Weapon backfires if these numbers are rolled.

SHIP STATISTICS

SHIP NAME	TONS	MC	AR	HP	SAVING THROW	SA	RAM	CREW
Angelship	33	C	6	33	Thick wood	3 lrg wpns	B	8/33
Barge of Ptah	60	F	8	60	Thin wood	12 lrg wpns	P	24/60
Bloatfly	48	E	6	48	Metal	36 lrg wpns	none	6/40
Caravel	10	F	9	10	Thick wood	1 lrg wpn	none	8/10
Cargo Barge	25	F	8	25	Thick wood	none	none	none
Coaster	10	F	9	10	Thick wood	1 lrg wpn	none	8/10
Cog	20	F	9	20	Thick wood	none	none	10/20
Damsefly	10	D	4	10	Metal	1 lrg wpn	none	2/10
Deathglory	70	D	6	70	Metal	9 lrg wpns	none	18/70
Deathspider	100	E	5	100	Crystal	6 lrg wpns	G	30/100
Dragonship	45	D	5	45	Thick wood	3 lrg wpns	none	20/45
Drakkar	10	F	7	10	Thick wood	1 lrg wpn	none	20/10
Dromond	16	E	9	16	Thin wood	3 lrg wpns	P	10/16
Dwarven Citadel	300	E	0	300	Stone	10 lrg wpns	B	100/300
Eel Ship	20	C	6	20	Thin wood	2 lrg wpns	none	4/20
Elven Armada	100	D	5	100	Ceramic	17 lrg wpns	none	40/100
Elven Flitter	1	B	8	1	Ceramic	none	none	1
Flying Pyramid	90	F	1	90	Stone	20 lrg wpns	none	6/90
Galleon	40	E	7	40	Thick wood	3 lrg wpns	none	20/40
Goblin Blade	2	A	4	2	Metal	1 lrg wpn	P	1/2
Great Galley	20	F	7	20	Thick wood	3 lrg wpns	P	15/20
Hammership	60	D	6	60	Thick wood	3 lrg wpns	B	24/60
Lamprey Ship	26	B	4	26	Thick wood	4 lrg wpns	special	8/26
Leaf Ship	70	D	6	70	Ceramic	5 lrg wpns	P	20/65
Longship	4	E	8	4	Thin wood	1 lrg wpn	none	4/4
Man-o-War	60	C	7	60	Ceramic	4 lrg wpns	none	10/60
Mindspider	40	C	4	40	Metal	3 lrg wpns	G/P, P	3/40
Monarch Armada	100	D	4	100	Ceramic	10 lrg wpns	none	40/100
Mosquito	6	C	5	6	Thin wood	none	none	1/6
Nautiloid	35	D	4	35	Thick wood	5 lrg wpns	P	10/35
Ogre Mammoth	90	E	4	90	Thick wood	9 lrg wpns	B	27/90
Porcupine Ship	30	D	7	30	Thin wood	4 lrg wpns	none	8/30
Scorpion	60	C	4	60	Metal	2 lrg wpns	special	6/60
Shrikeship	30	B	5	30	Thick wood	4 lrg wpns	P	14/30
Sidewheeler	30	E	7	30	Metal	none	none	20/30
Skeleton Ship	var.	C	9	var.	Bone	2 lrg wpns	none	1/var.
Space Leviathan	400	F	3	400	Metal	11 lrg wpns	B	?/400
Spelljammer	1.5 m.	B	5	1.5 m.	W20	140 lrg wpns	none	1?/5,240?
Squid Ship	45	D	5	45	Thick wood	3 lrg wpns	P	12/45
Stoneship	300	E	0	300	Stone	10 lrg wpns	B(x3)	54/300
Swan Ship	32	C	7	32	Thin wood	3 lrg wpns	none	12/32
Thorn Ship	3	B	7	3	Ceramic	2 lrg wpns	none	1/6
Tradesman	25	D	5	25	Thick wood	2 lrg wpns	none	10/25
Turtle Ship	40	D	3	40	Metal	4 lrg wpns	B	12/40
Tyrant Ship	23	C	0	23	Stone	none	none	15/23
Vipership	29	A	5	29	Metal	5 lrg wpns	P	1/29
Wasp	18	D	6	18	Thick wood	1 lrg wpn	none	8/18
Wreckboat	4	A	6	4	Thick wood	0-1 lrg wpn	none	1/4

Large weapons include all ranks of ballistas and catapults.

Rams: B = Blunt; G = Grappling; P = Piercing.



SQUIDSHIP TENTACLES

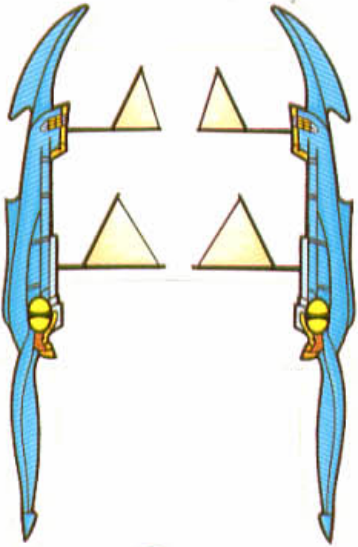

FLUTTER WINGS

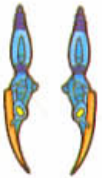
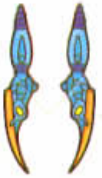

HAMMERSHIP FRONT FINS



HAMMERSHIP HEAD



HAMMERSHIP



HAMMERSHIP REAR FINS

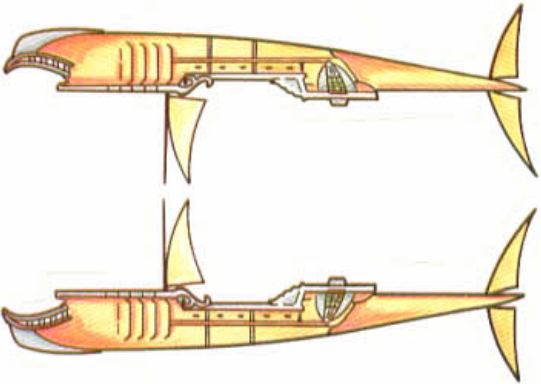

HAMMERSHIP



FLUTTER WINGS

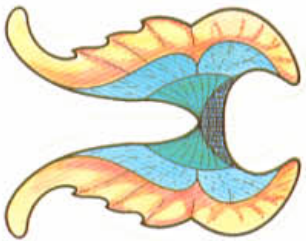

FLUTTER WINGS

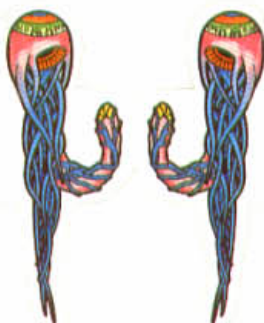
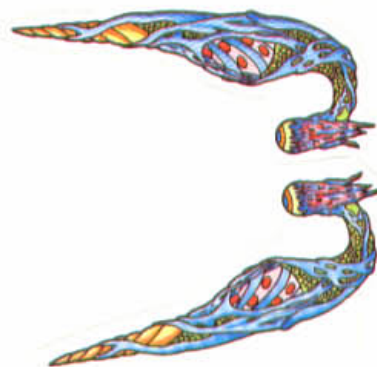
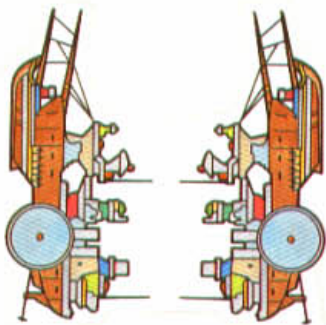
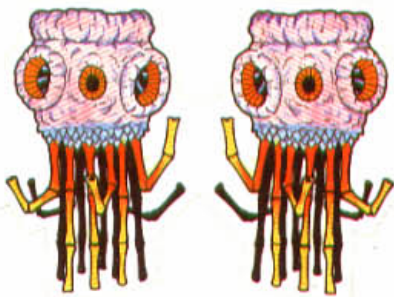

TYRANT SHIP TENTACLES



TYRANT SHIP TENTACLES

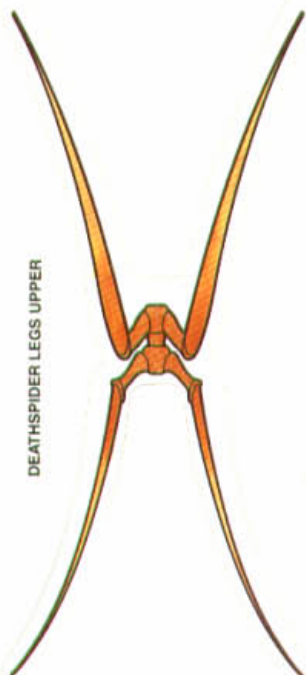

DEATHSPIDER LEGS UPPER



DEATHSPIDER LEGS LOWER

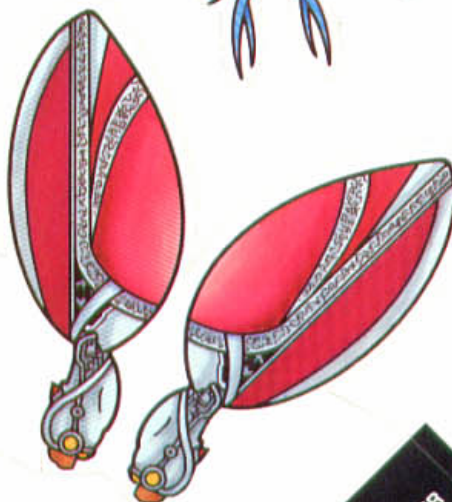
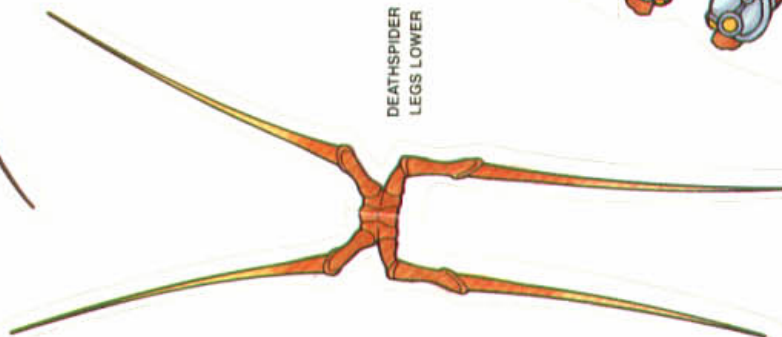

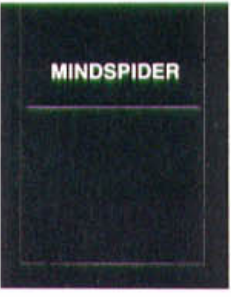
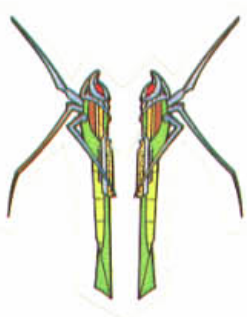
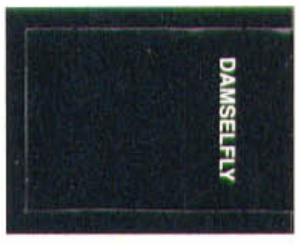
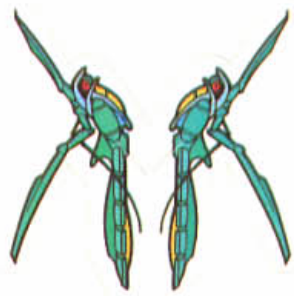
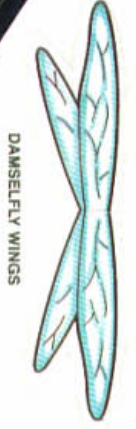
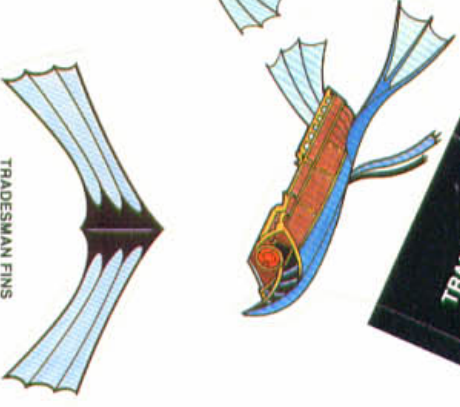
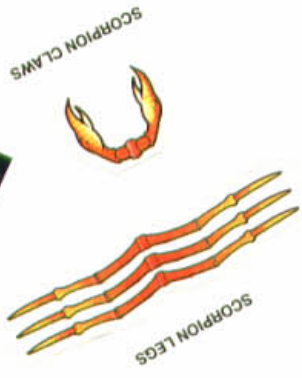
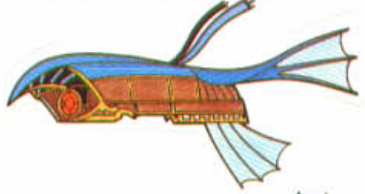
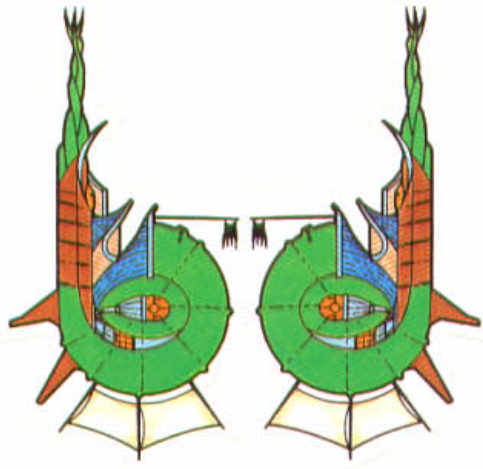

TRADESMAN FINS

MINDSPIDER LEGS

DRAGONFLY WINGS

DAMSELFLY WINGS

SCORPION CLAWS

SCORPION LEGS

TRADESMAN

NAUTILOID

NAUTILOID

TRADESMAN

SCORPION

MINDSPIDER

SCORPION

DAMSELFLY

DAMSELFLY

DRAGONFLY

DRAGONFLY

MINDSPIDER

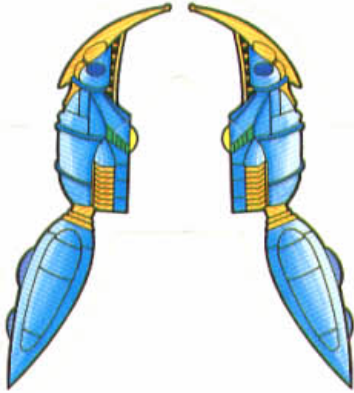
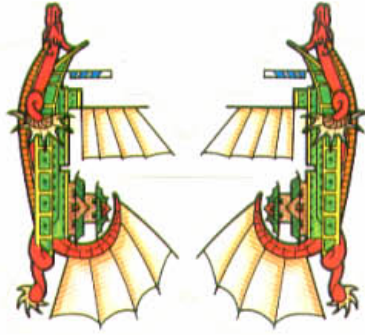

MAN-O-WAR WINGS

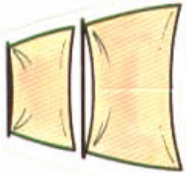
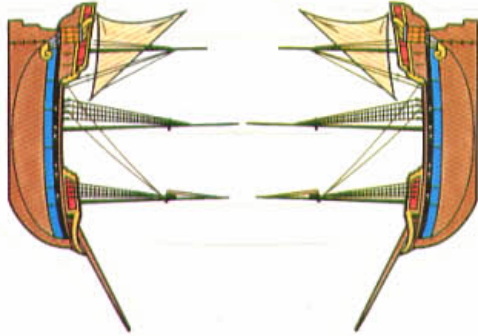
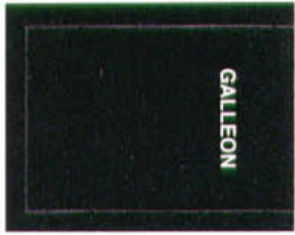
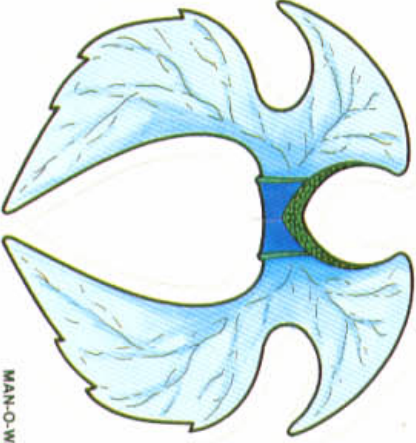

GALLEON REAR SAILS

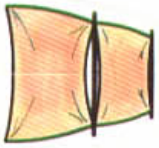

GALLEON FRONT SAILS

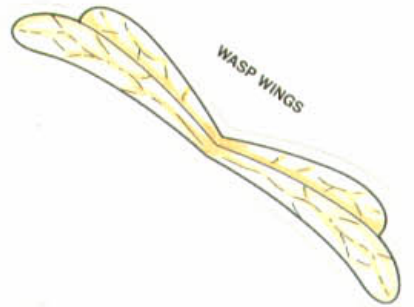
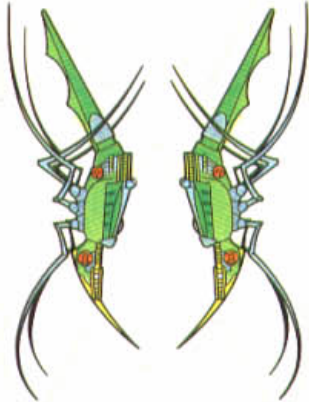

WASP WINGS

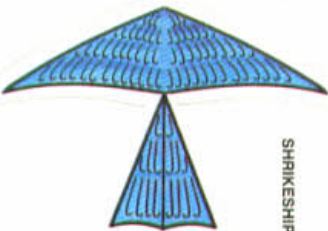
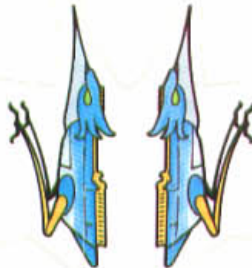

SHRIKESHIP WINGS

Dungeon Master's Screen

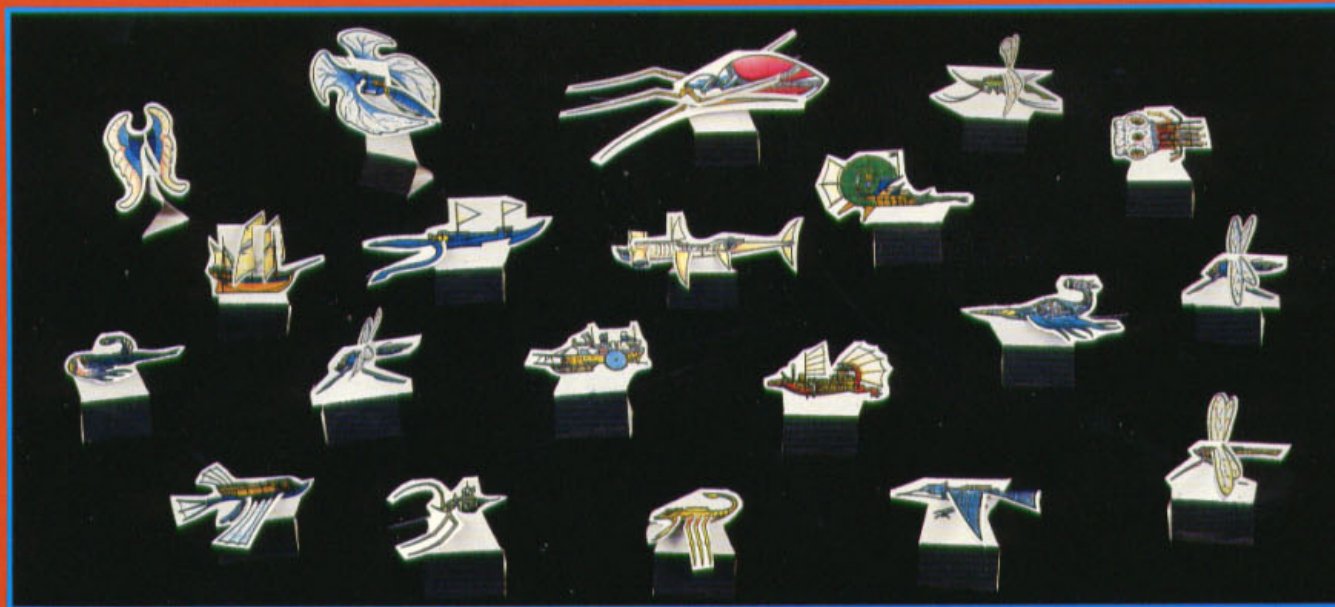

including
3-D SPELLJAMMER™ Campaign Ships
by Diesel

SCANNED BY: JACK D. KNIGHT - GAMEBOOKZ / DALNET

This *all new* AD&D® Dungeon Master's Screen has been designed especially for use with the SPELLJAMMER™ campaign system. From basic combat tables to planetary statistics, the screen provides all the special tables needed to smoothly run an AD&D space campaign, placing them immediately within the DM's reach. In addition to the useful tables, the screen gives you:

- combat statistics for your favorite ships from *Lost Ships* and the SPELLJAMMER campaign adventures!
- a 3-panel panoramic painting depicting an epic battle in wildspace
- full color three-dimensional fold-ups of space-faring ships suitable for use in ship-to-ship combat

TSR, Inc
POB 756
Lake Geneva
WI 53147 U.S.A



TSR Ltd.
120 Church End, Cherry Hinton
Cambridge CB1 3LB
United Kingdom

ISBN 1-56076-053-2



9313XXX1401

\$8.95 U.S. £6.50 INC. VAT.